

Acrylic Solid Surfaces

أسطح الأكريليك الصلبة

The Expert in This Field



INNOVATIVE
TECHNICAL
FOR WOOD INDUSTRIES









Acrylic solid surfaces are among the greatest material for furniture and counters. They give any area a clean, contemporary, and streamlined look. Acrylic is an excellent choice for both home and commercial areas since it is long-lasting, easy to maintain, and reasonably priced.

It can be readily cut, routed, and sanded like wood and formed into countertops, shower walls, external cladding for buildings, signage and furniture where non-porosity and infrequent maintenance are highly valued. These are just a few of the many applications.

Acrylic Solid Surface Characteristics

We rely on Hanex Solid Surfaces for Acrylic works because it's an ideal material for residential and commercial applications, and it's beauty, durability, aesthetics, design flexibility, and color choices. Acrylic Solid Surfaces from Hanex are manufactured in USA.



-  Design Flexibility
-  Class A fire rating
-  Hygienic & Antibacterial
-  Environmentally Friendly
-  Custom design, Durable, and Renewable
-  Stain Resistance
-  Water & Moisture Resistance
-  Heat & Cigarette Burn Resistant

They can be used in many applications where sanitation is of utmost importance, such as kitchen countertops, hospitals, playrooms, schools and many more.

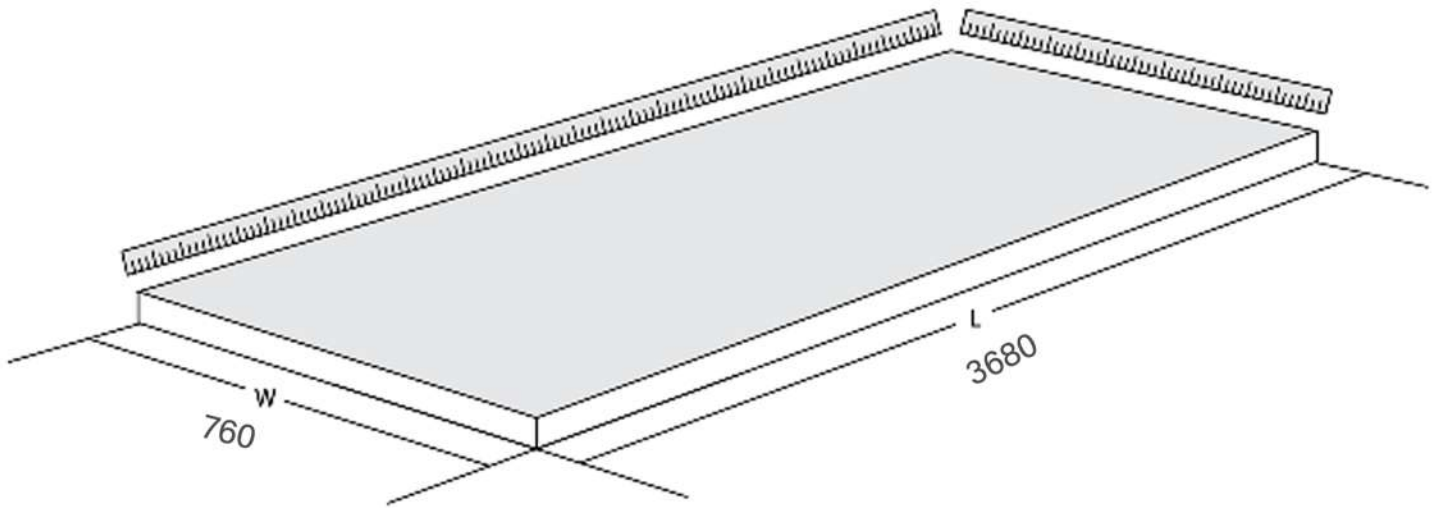

3680 x 760 x 12 mm

In addition to being workable like hard wood, it can be heated and thermoformed into curved and molded shapes. It can also be printed on using dye-sublimation techniques that deposit the ink just below the surface, so the image becomes permanent.

Innovative technical foundation will fulfill all your design dreams with unique designs and a timeless color pallet. Achieve your goals while still choosing a high-quality product that can withstand anything your life throws at it. You may relax knowing that you have chosen a surface that will last a lifetime!



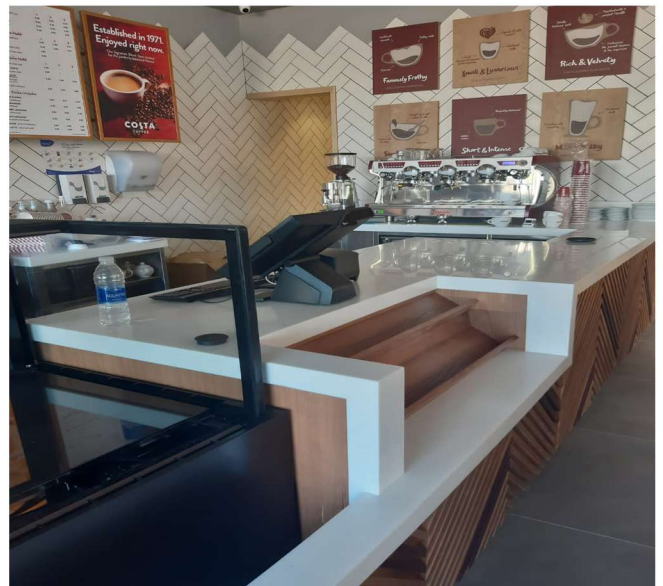

System Advantages

- » Modular
- » Durable
- » Flexible
- » Design friendly
- » Decorative
- » Easy to install
- » Cost Efficient
- » Maintenance free

Innovative Technical

phone: +962796464940

website: www.itc-jo.co

email: info@itc-jo.co

address: Jordan-Amman-Abu Alanda- Industrial area



**INNOVATIVE
TECHNICAL**
FOR WOOD INDUSTRIES